

die Vorbereitung des Papiers

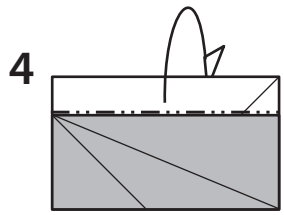

Entlang der oberen Kante
Papier nach hinten falten.

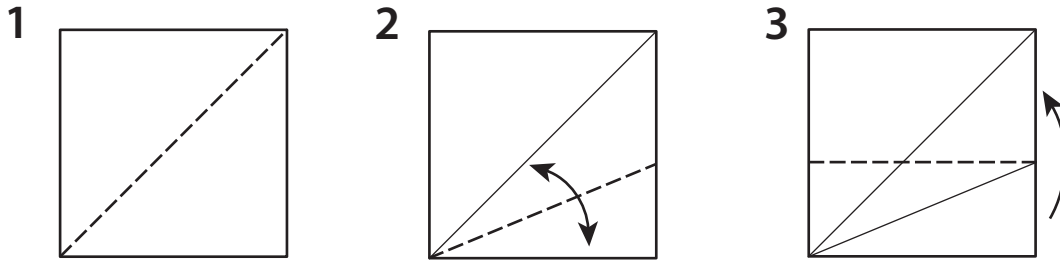
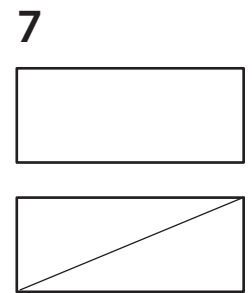
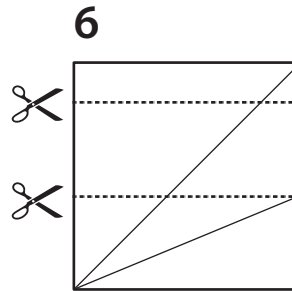
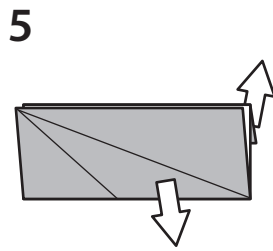

das Modul

Anmerkung: Wenn im vorbereiteten Modulstreifen die Diagonale bereits vorhanden ist, weiter mit **Schritt 9**.

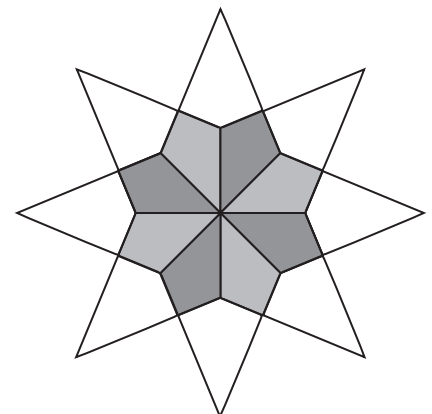
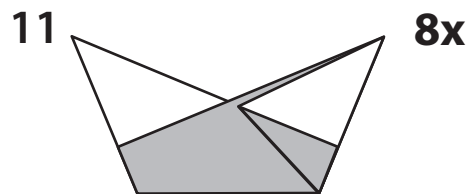
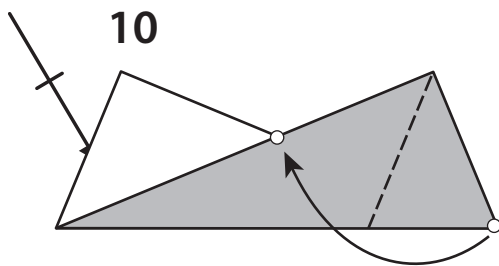
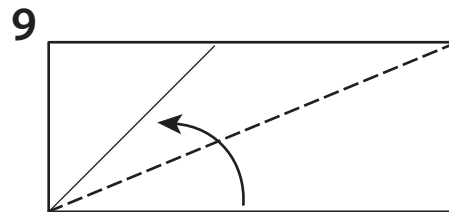
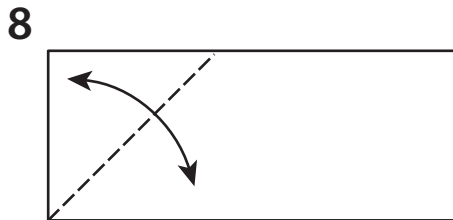

der Zusammenbau

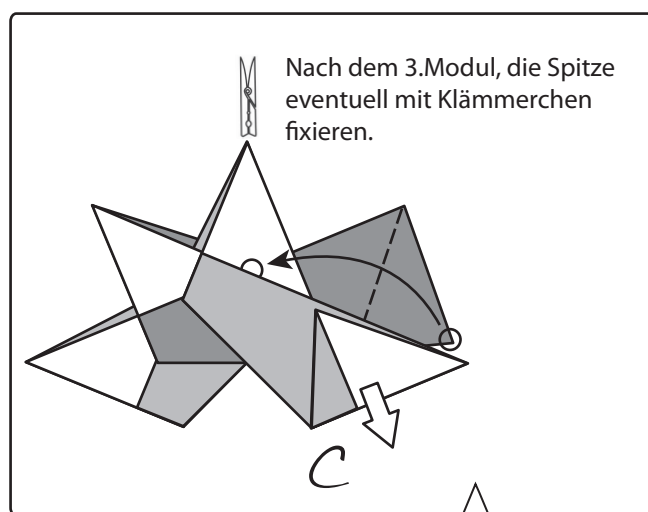
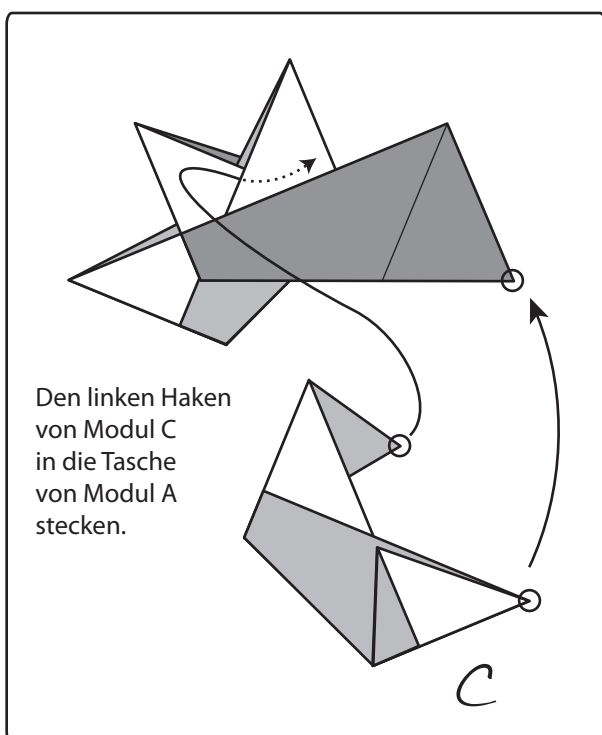
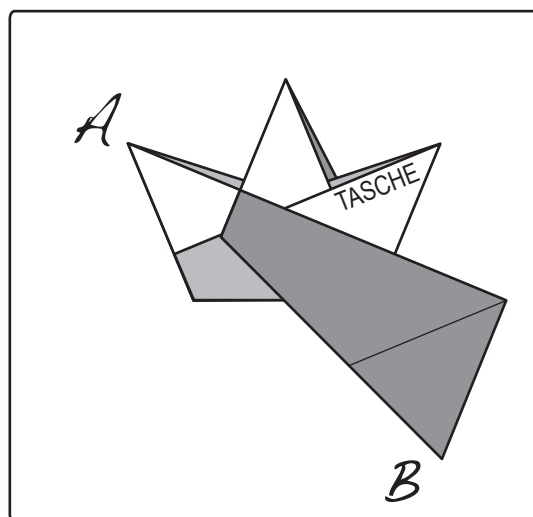
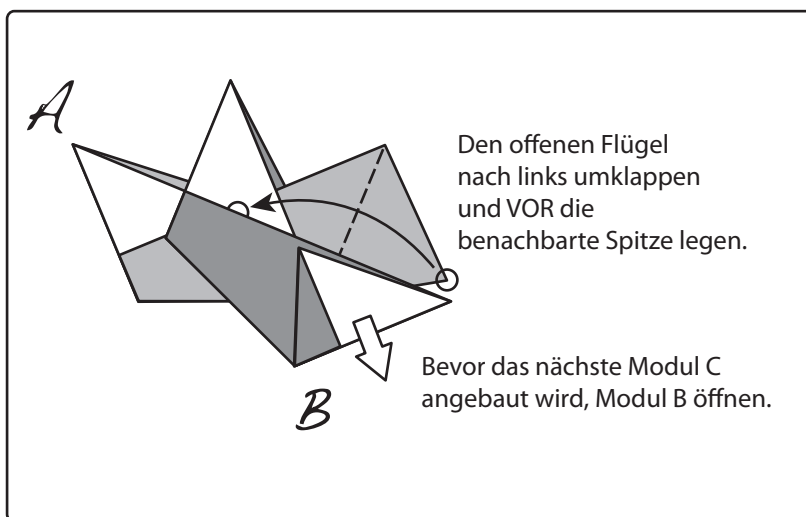
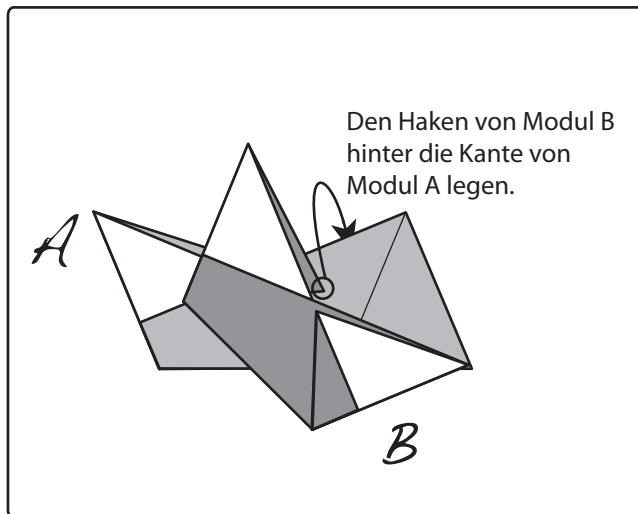
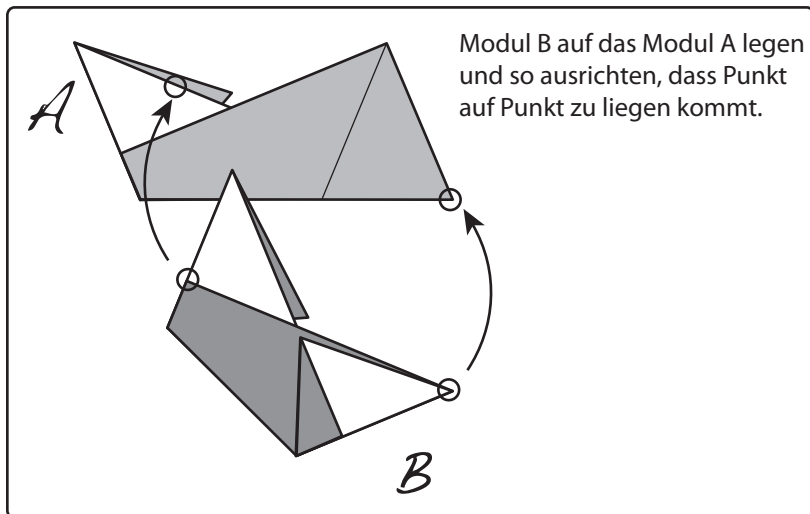

8 Module ergeben diesen Stern:

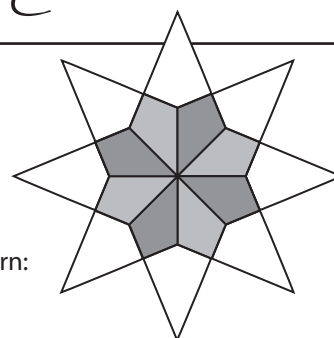

Variante

Insgesamt **16 Streifen** zuschneiden, wie in **Schritt 1-6** beschrieben.

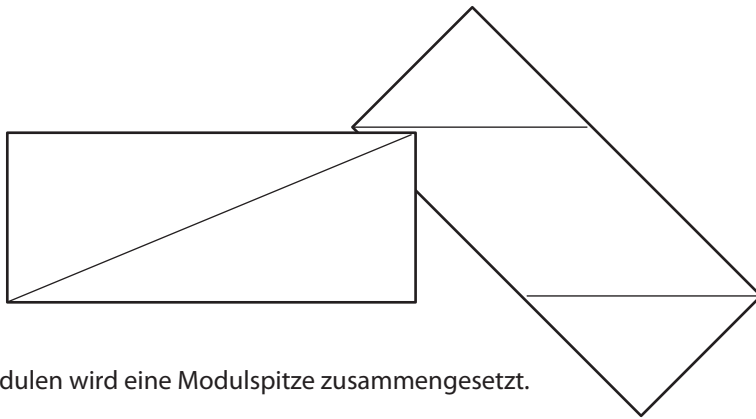
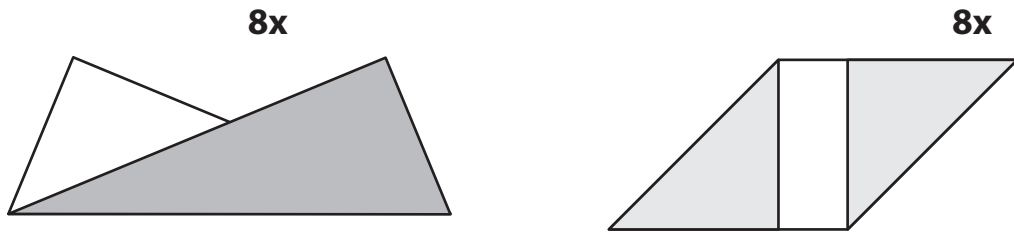

Aus 2 Teilmodulen wird eine Modulspitze zusammengesetzt.

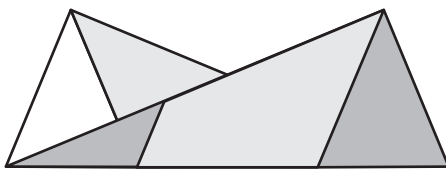
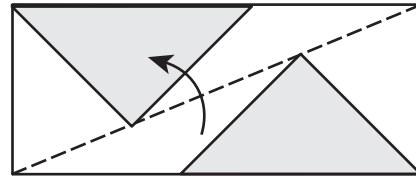
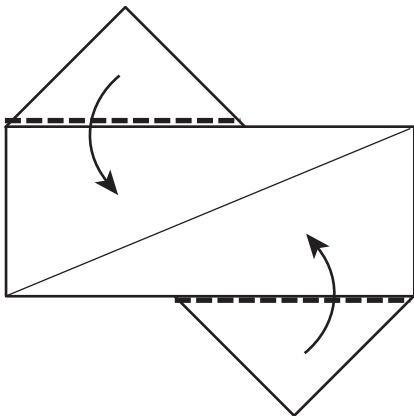

Weiter mit **Schritt 10** in der ursprünglichen Anleitung.

8 „eingewickelte“ Module ergeben diesen Stern:

