

# Strelitzia

Peterpaul Forcher  
STRELITZIA / Seite 1

## ORIGAMI

von Peterpaul FORCHER  
(Österreich)

1997

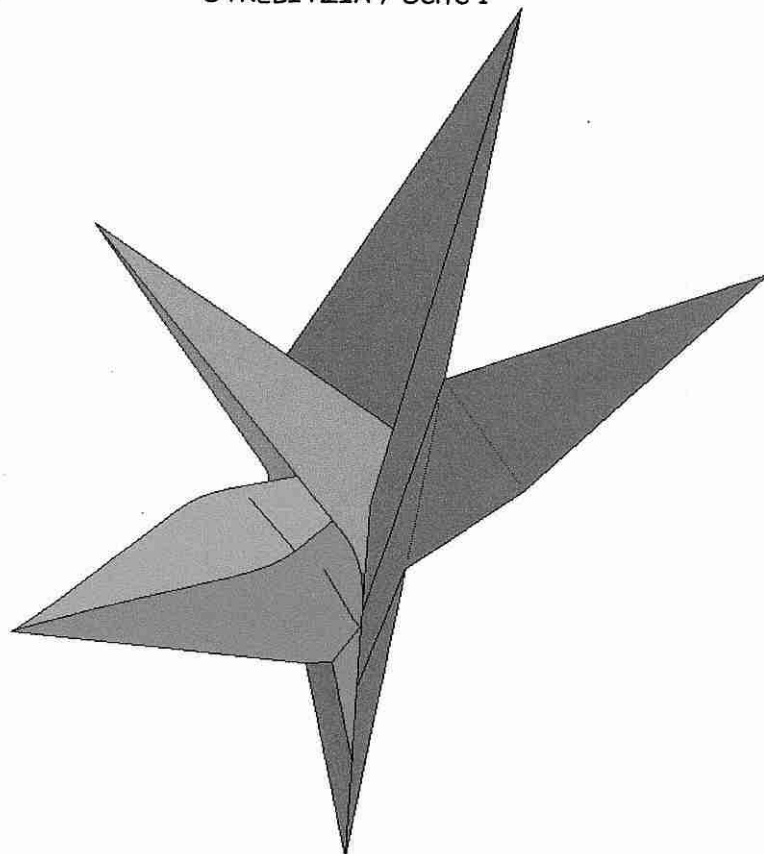
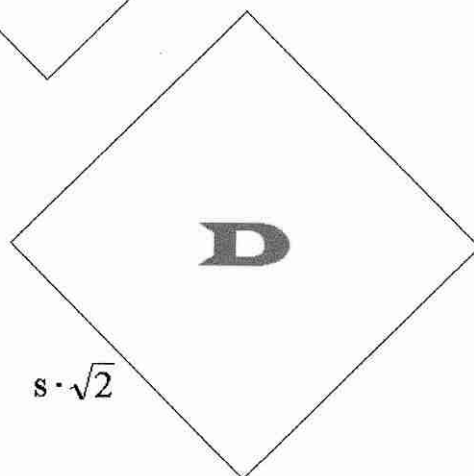
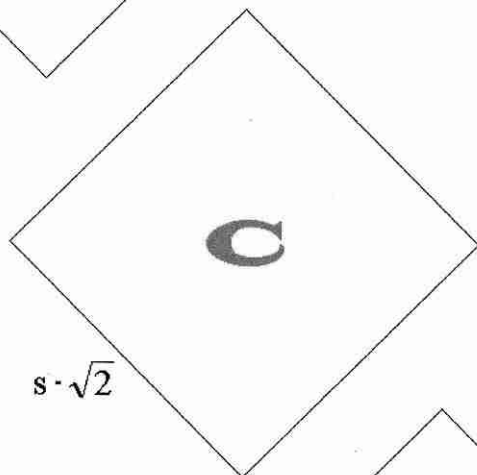
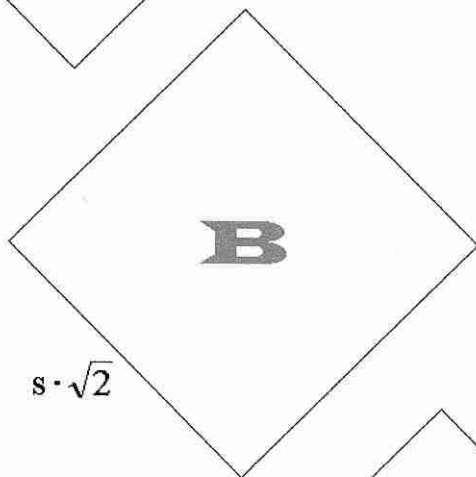
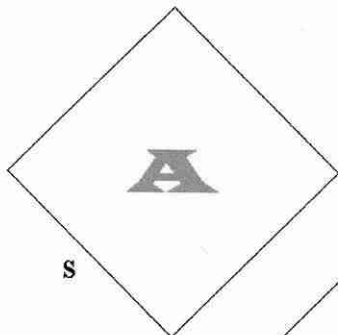

# Strelitzia

Peterpaul Forcher  
STRELITZIA / Seite 2

## Teil A

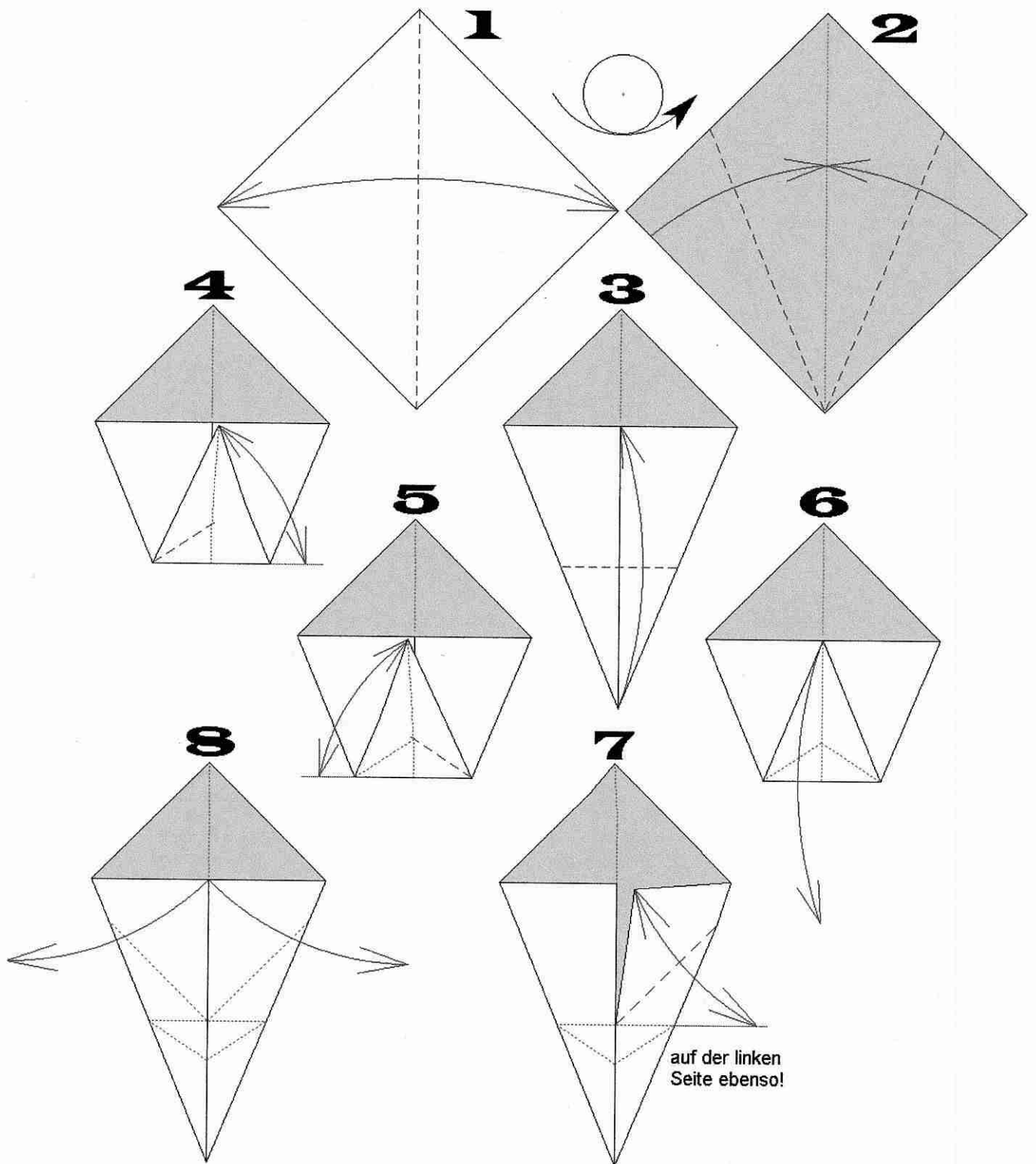

**9**

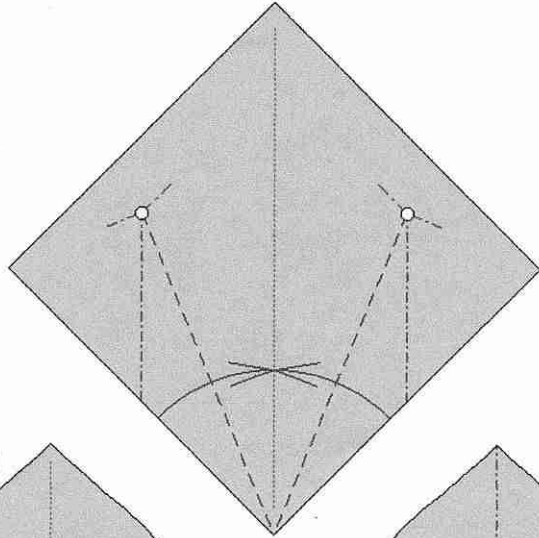

**10**

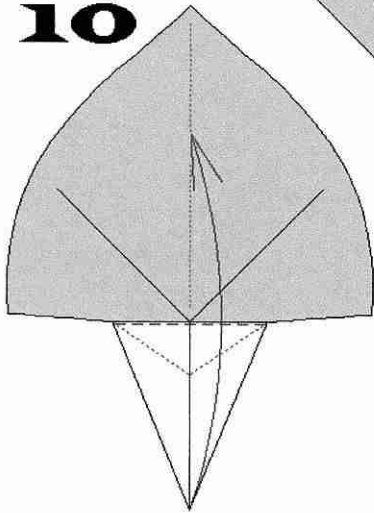

**11**

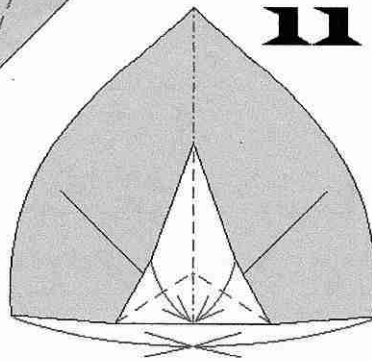

**13**

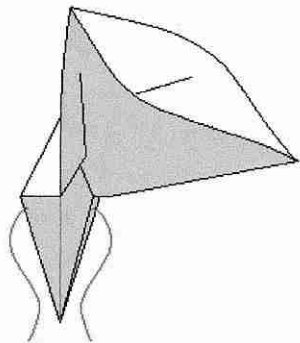

die seitlichen Dreiecke in das  
Innere von Teil B schieben!

**12**

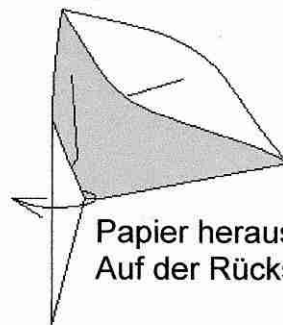

Papier herausziehen!  
Auf der Rückseite ebenso!

## Teil B

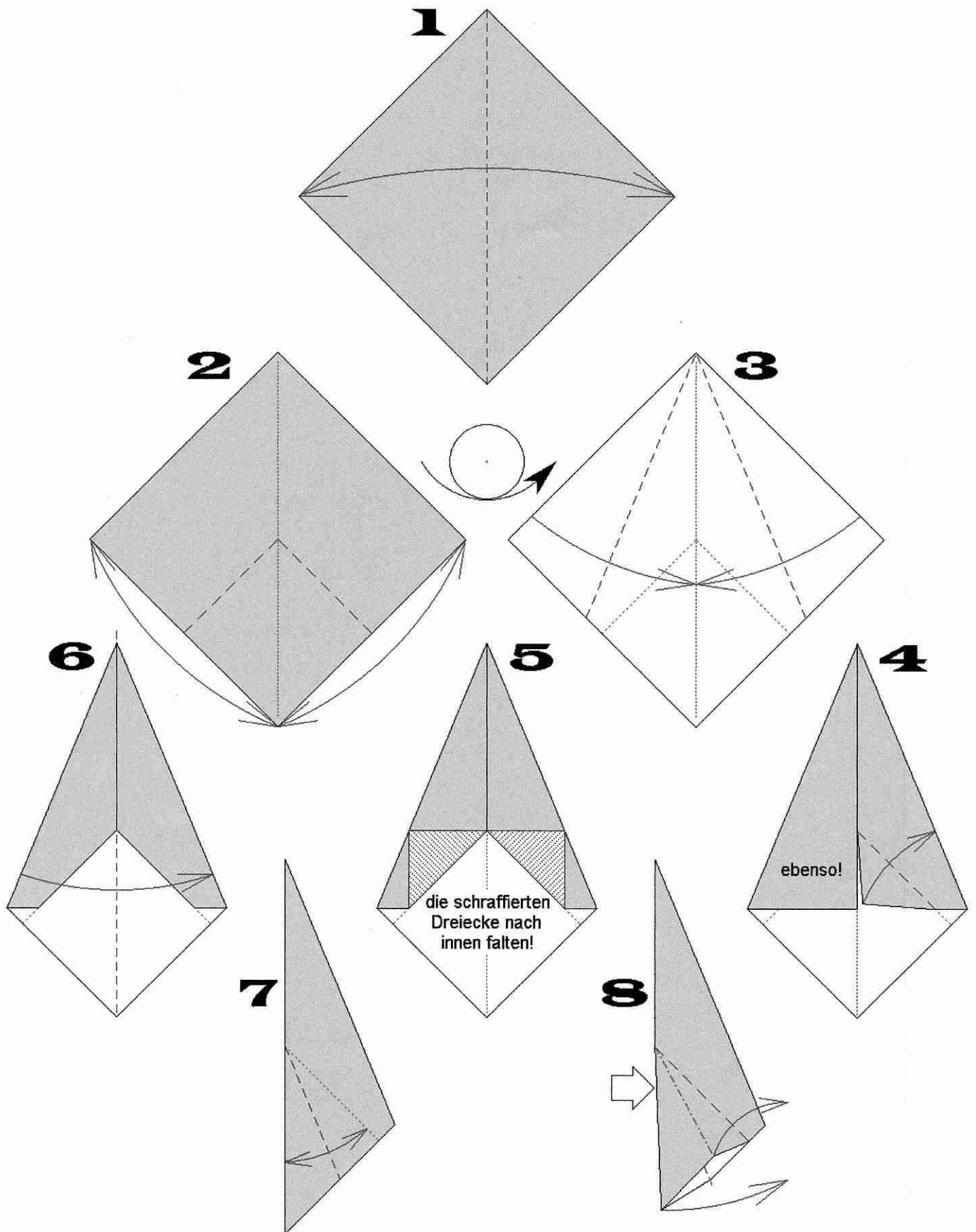

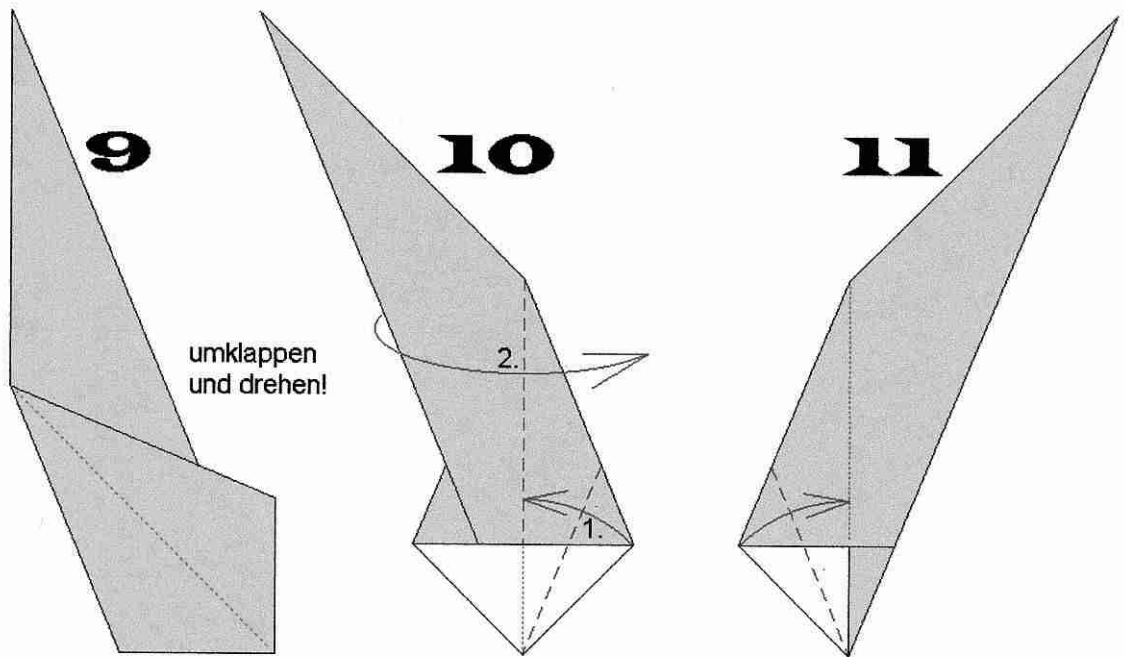

umklappen  
und drehen!

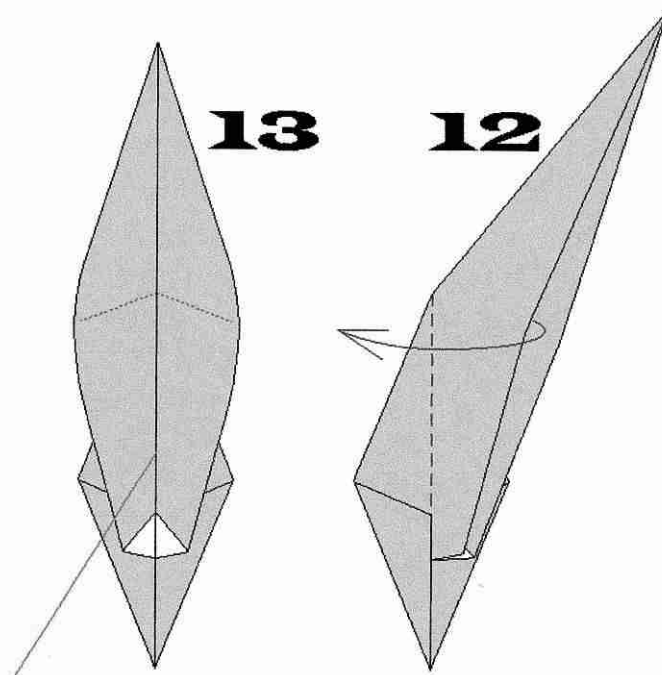

die seitlichen Dreiecke von Teil A durch  
diesen Spalt ins Innere schieben!

## Teil C

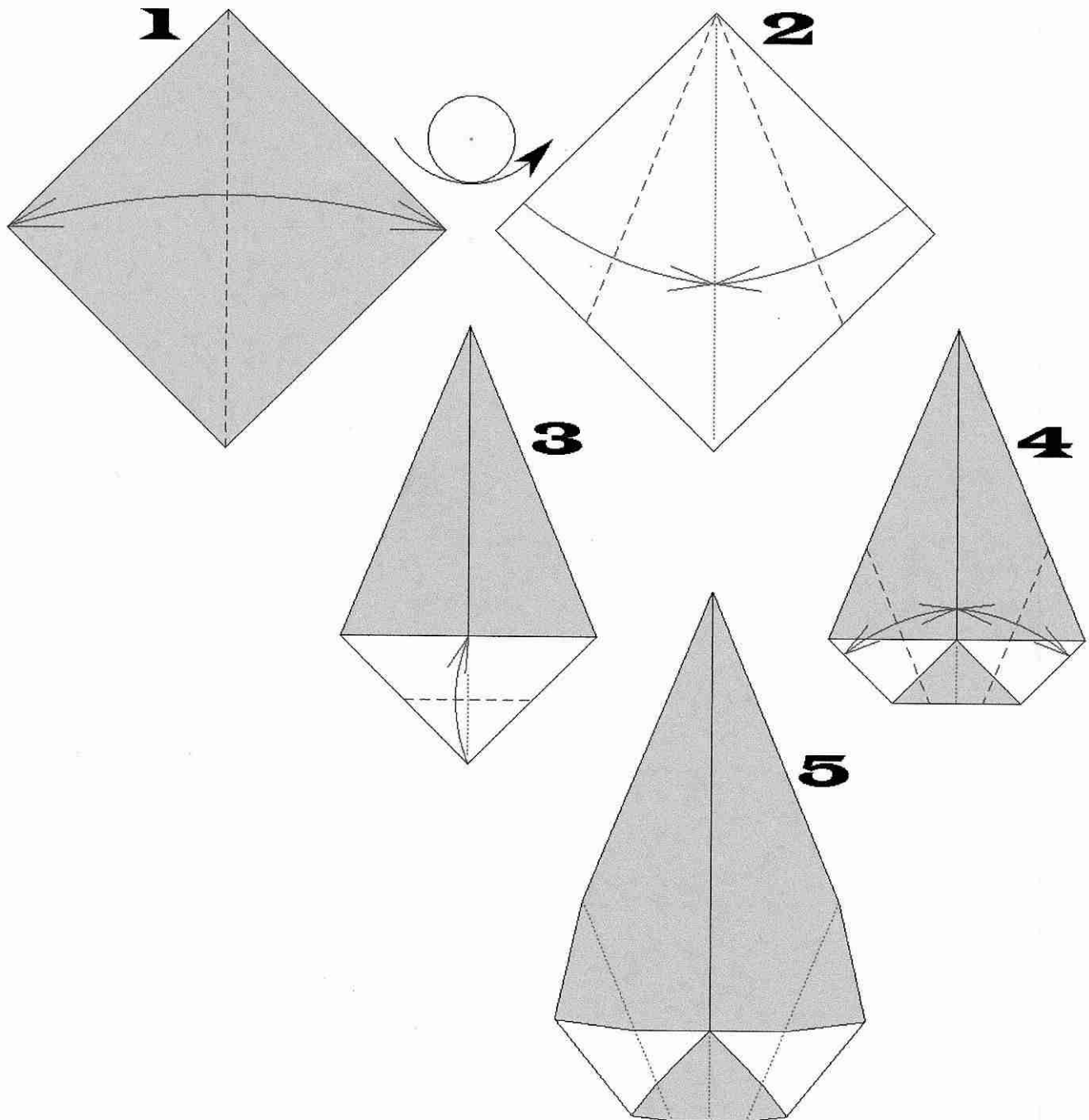

# Strelitzia

Peterpaul Forcher  
STRELITZIA / Seite 7

## Teil D

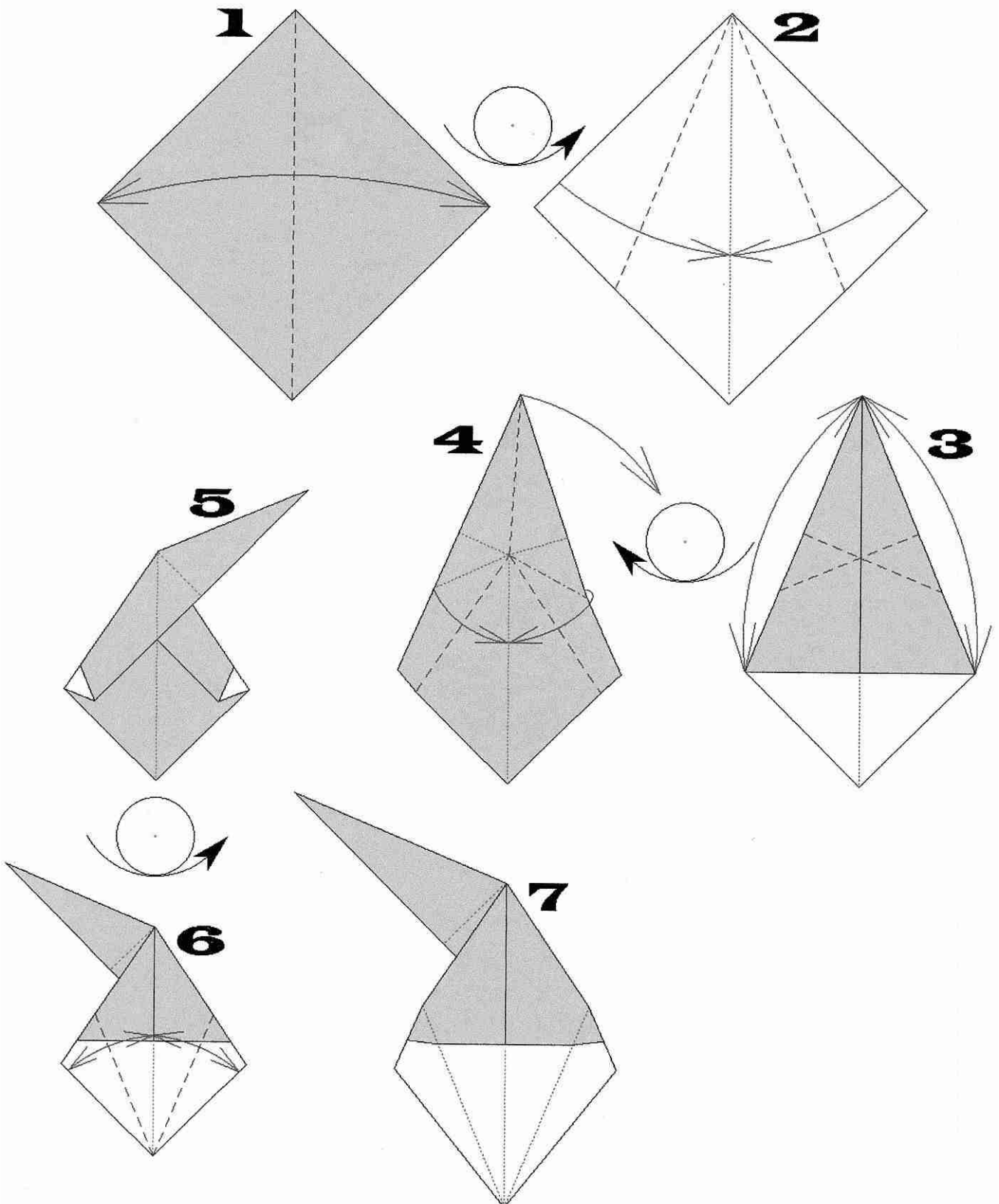

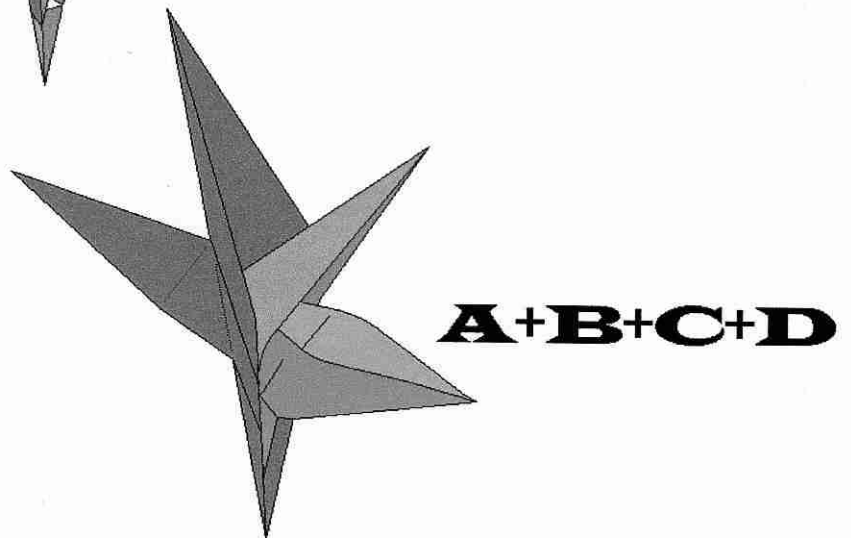
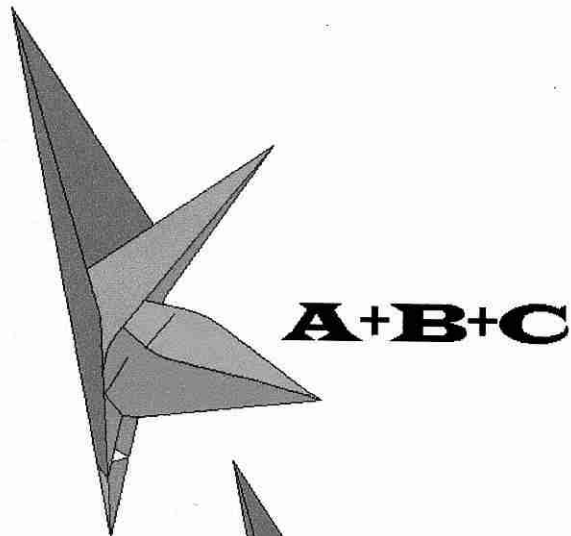
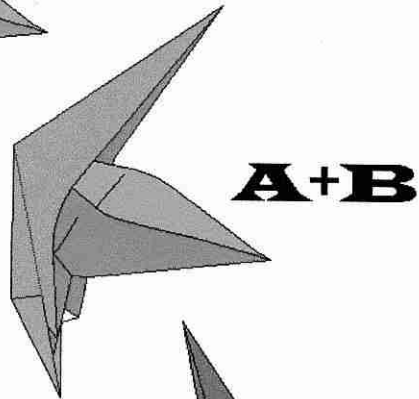
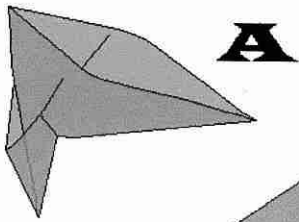

# ORIGAMI

von Peterpaul FORCHER  
(AUSTRIA)

Diagramme fertig: 4. Okt. 1997