

# INTI

(Inka-Sonnengott)

## ORIGAMI

von Peterpaul FORCHER (AUSTRIA)

**1**

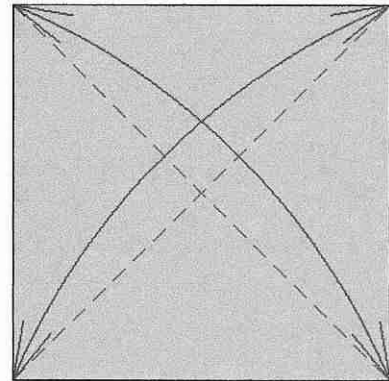

**2**

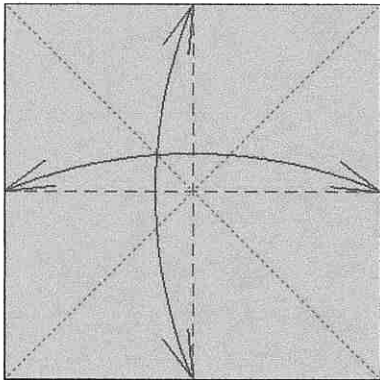

**3**

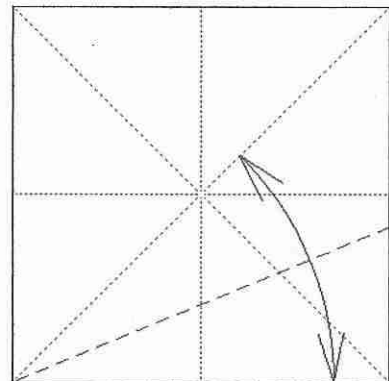

7mal wiederholen!

**4**

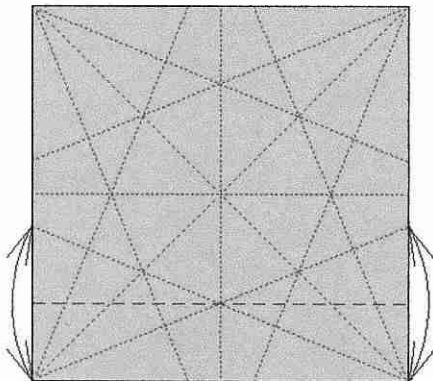

3mal wiederholen!

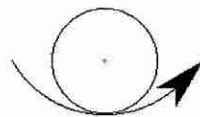
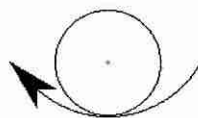
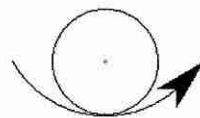

**5**

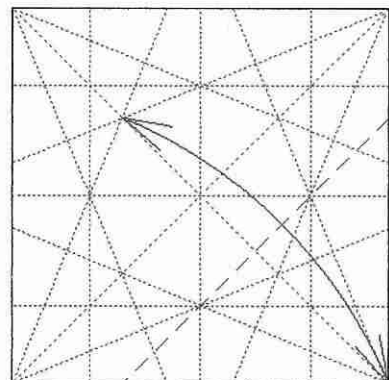

3mal wiederholen!

**6**

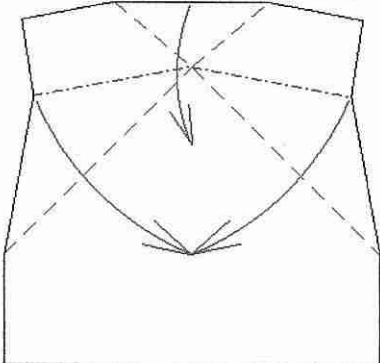

**7**

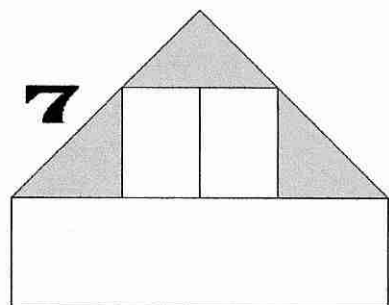

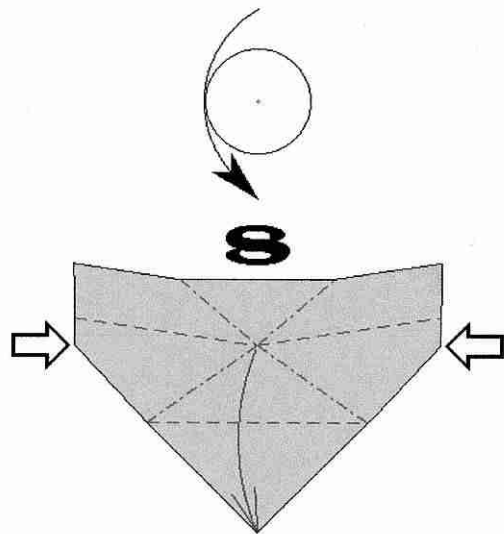

# ORIGAMI

von Peterpaul FORCHER  
(AUSTRIA)

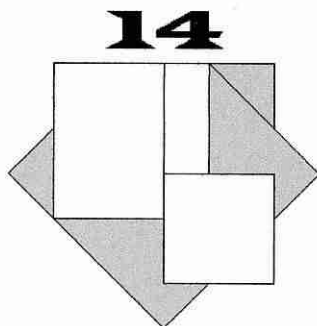
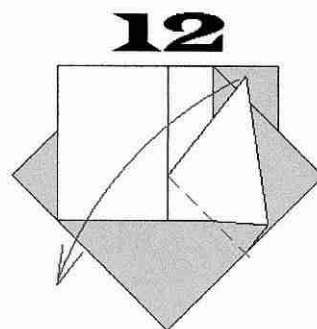
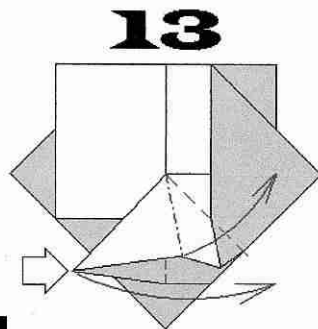
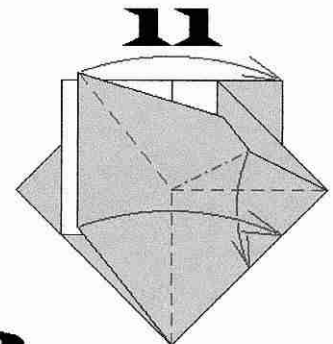
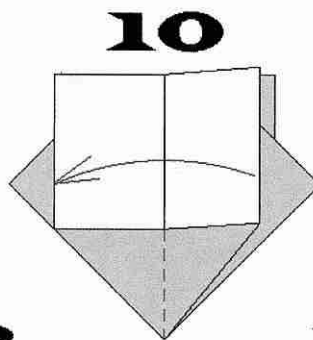
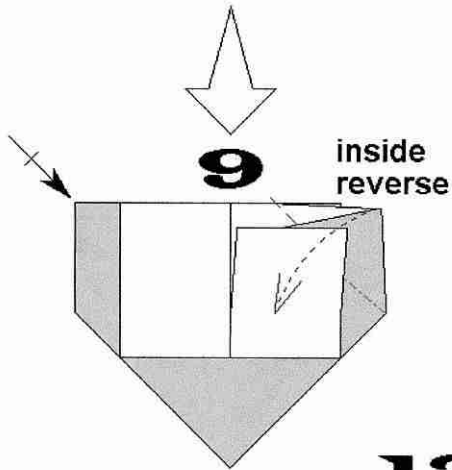

**10 bis 13**  
3mal wiederholen!  
(links vorne und 2mal  
auf der Rückseite)

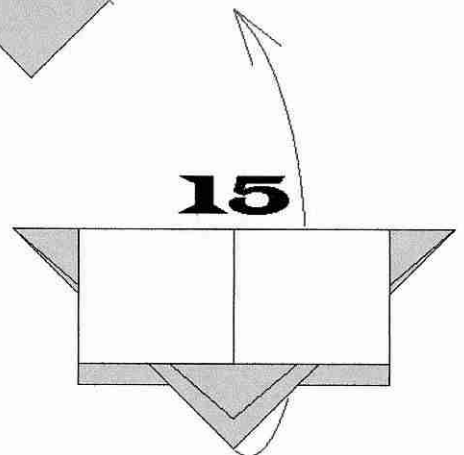

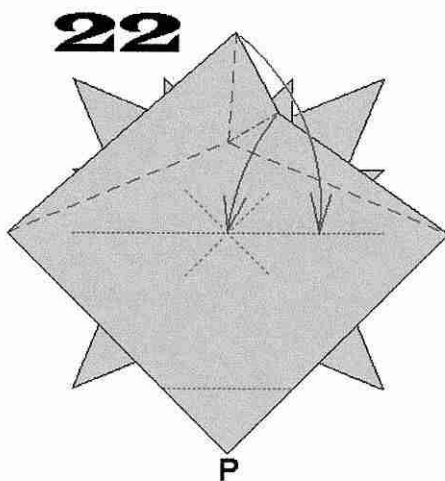
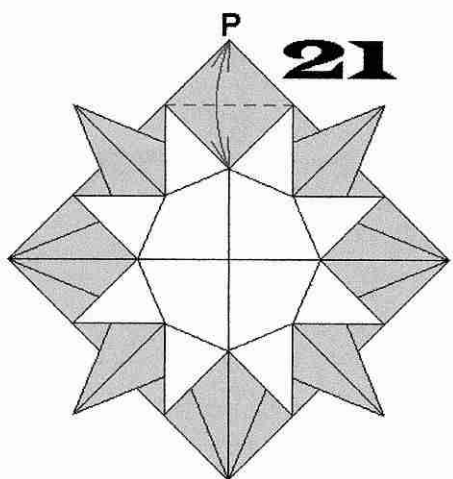
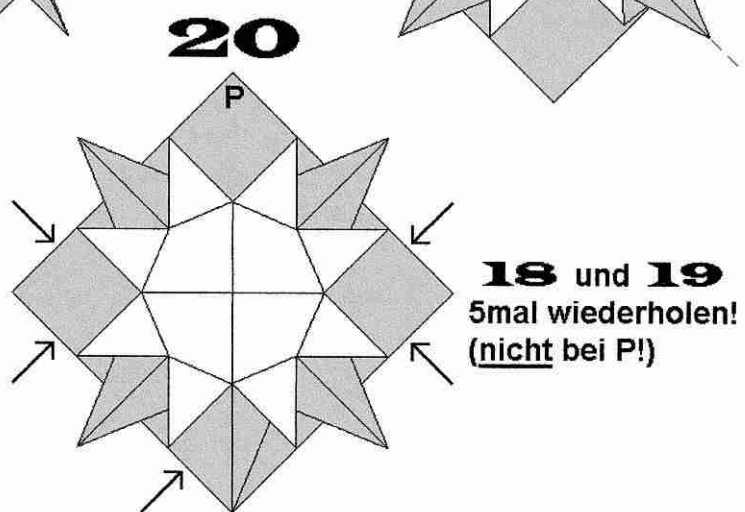
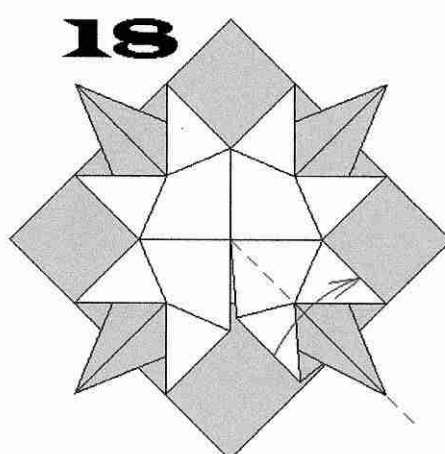
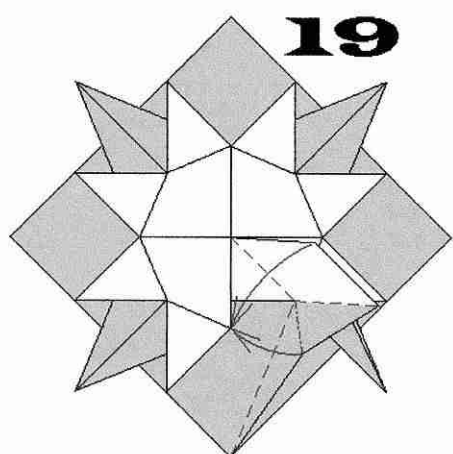
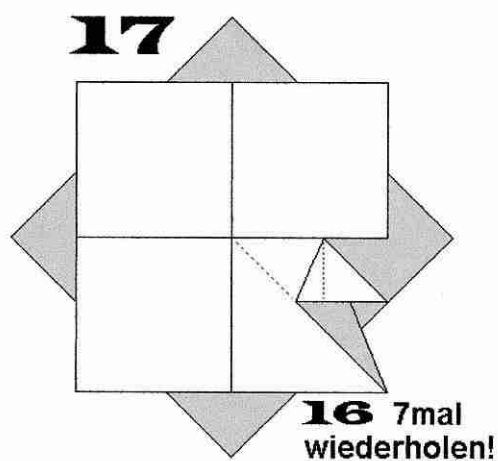
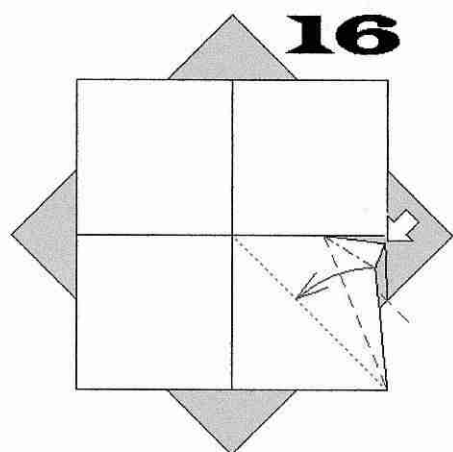

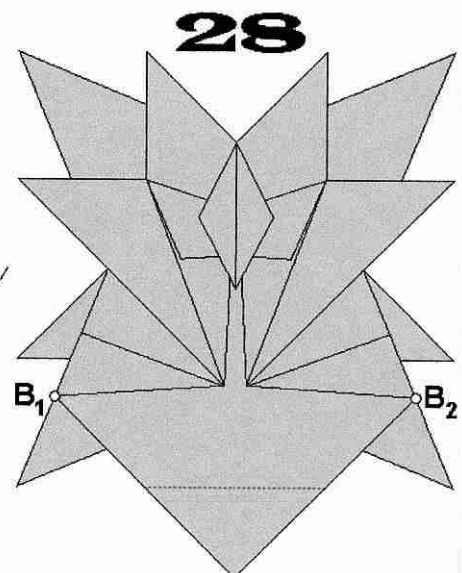
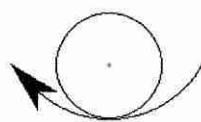
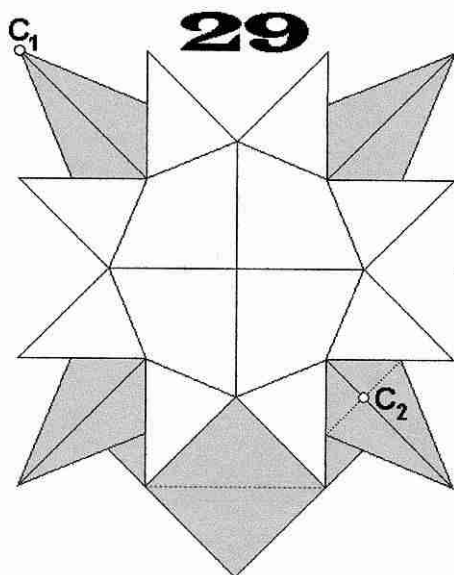
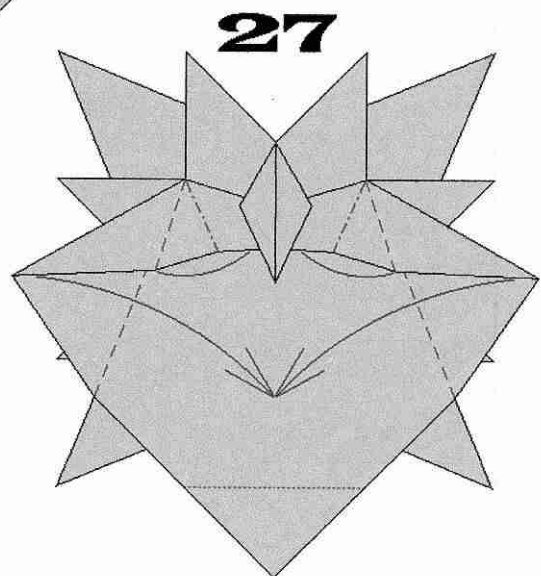
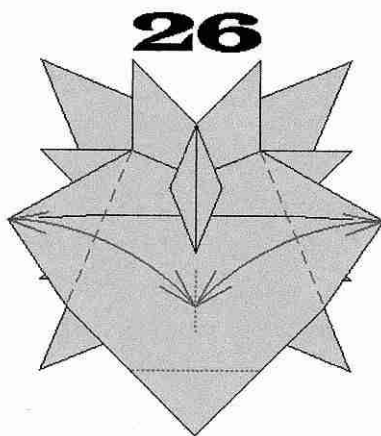
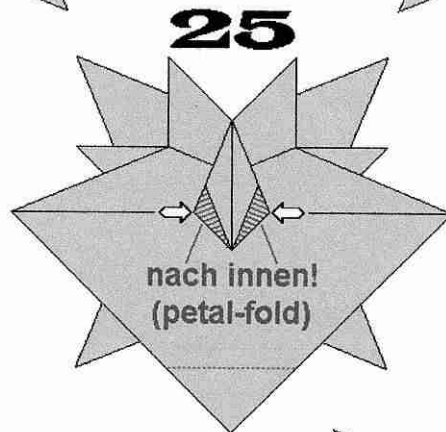
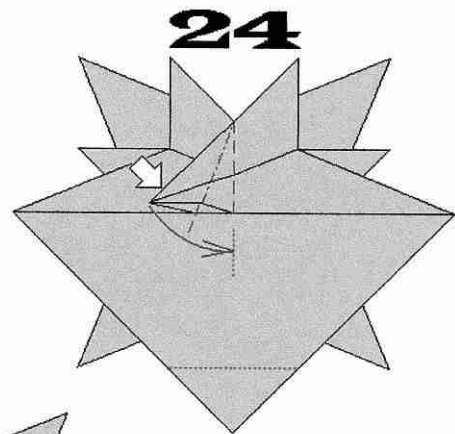
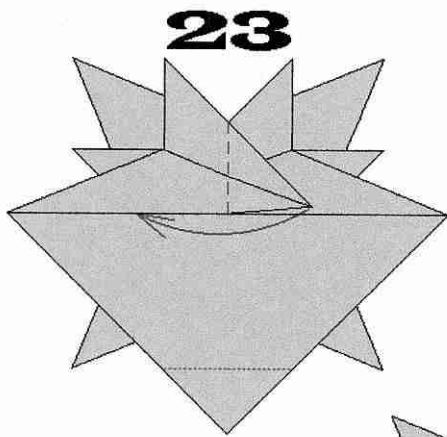

# INTI

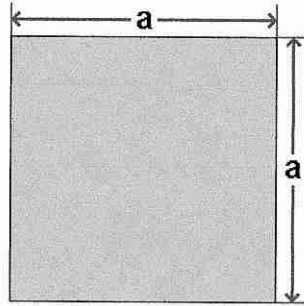

# Stütze

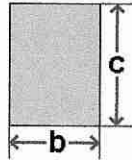

$$b = \overline{B_1 B_2} \text{ (siehe 28)}$$

$$c = \overline{C_1 C_2} \text{ (siehe 29)}$$

Oder:

$$b = 2a \cdot (3 - 2\sqrt{2}) \approx a \cdot 0,3431$$

$$c = \frac{a}{2} \cdot (8 - 5\sqrt{2}) \approx a \cdot 0,4645$$

**30**

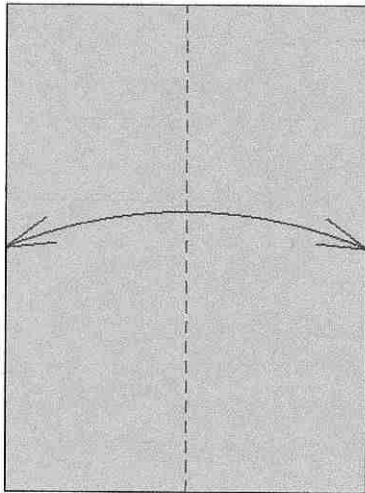

**31**

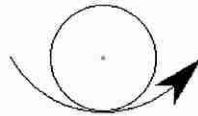
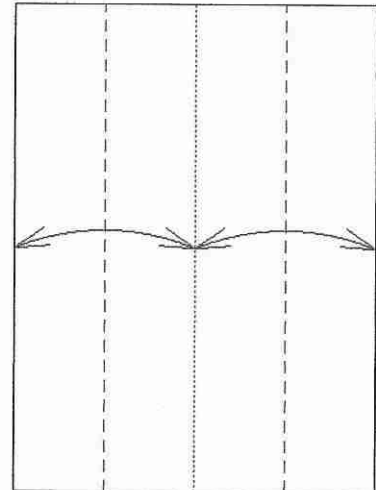

**34**

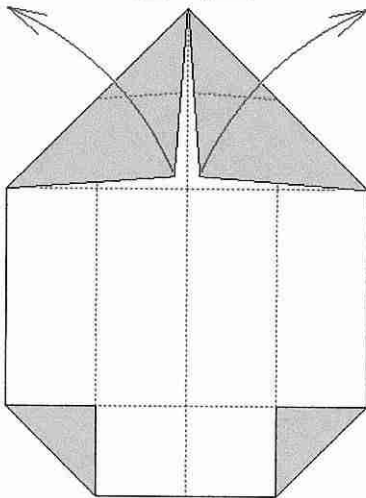

**33**

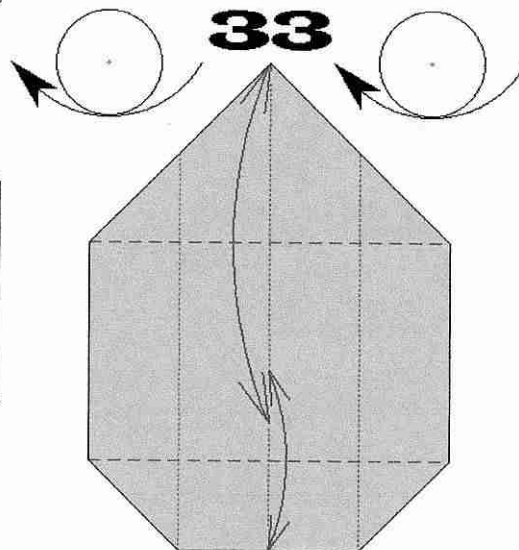

**32**

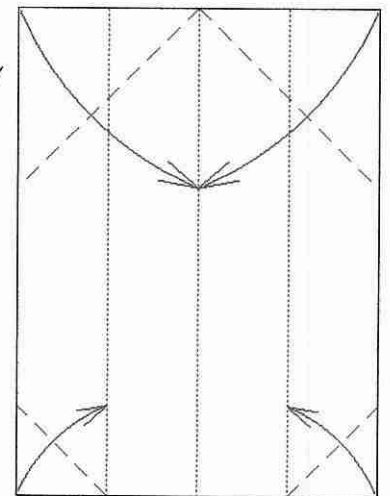

**35**

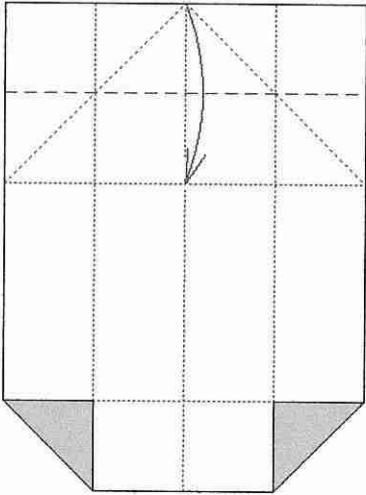

**36**

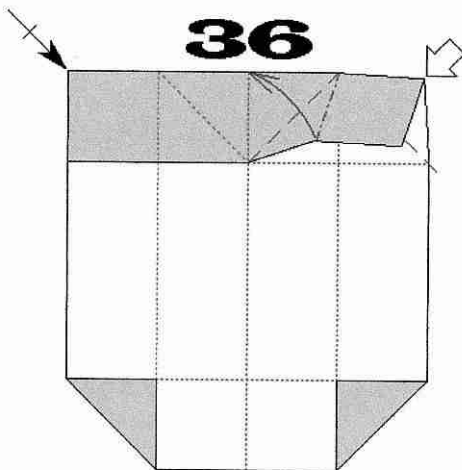

**37**

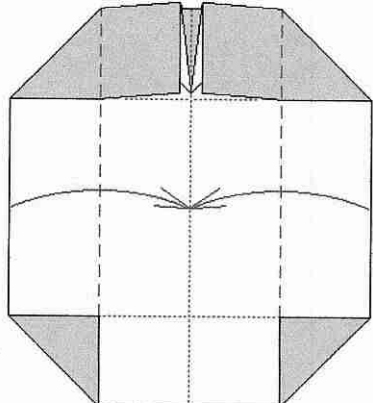

**39**

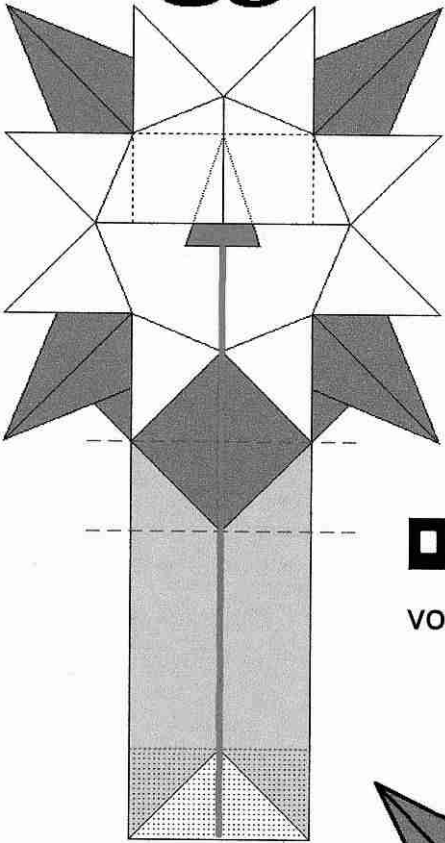

**38**

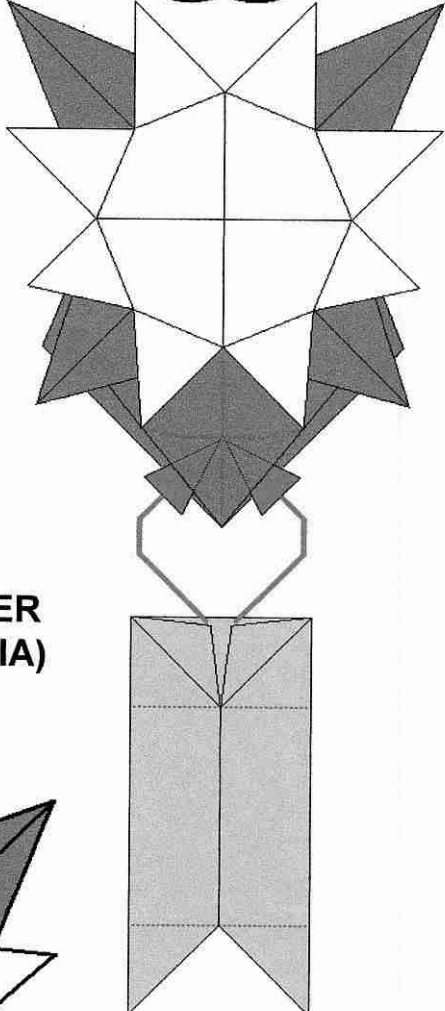

**ORIGAMI**  
von Peterpaul FORCHER  
(AUSTRIA)

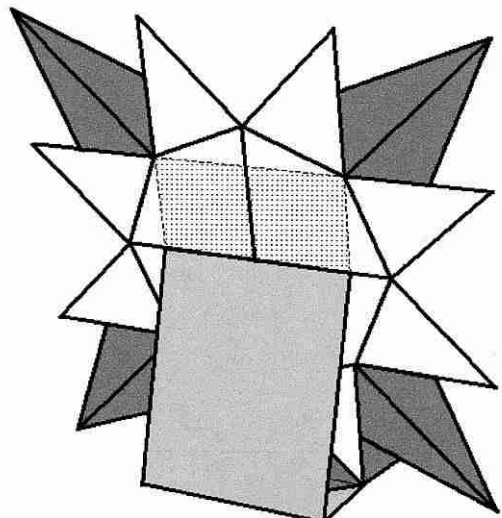

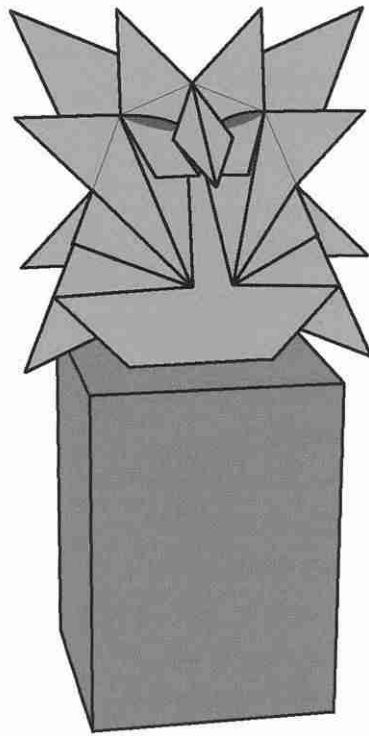

Peterpaul Forcher  
INTI / Seite 7

Diagramme fertig: 28. März 1999

# ORIGAMI

von Peterpaul FORCHER  
(AUSTRIA)